



gorenje BY S+ARCK®

Marketing sales presentation

Contents

01

About Philippe Starck

02

Design

03

Line up

04

Marketing
Communication

Philippe Starck is an internationally acclaimed French creator, designer and architect.

His profound comprehension of contemporary mutations, his determination to change the world, his anticipatory concern for environmental implications, his love of ideas, his desire to defend the intelligence of usefulness - and the usefulness of intelligence - have accompanied one iconic creation after the other. From everyday products such as furniture and lemon squeezers, to revolutionary mega-yachts, individual windmills, electric bikes or hotels and restaurants that aspire to be wondrous, stimulating and intensely vibrant places.

Philippe Starck and his wife, Jasmine, mostly live on an airplane or in "middles of nowhere."



Famous designs by Starck

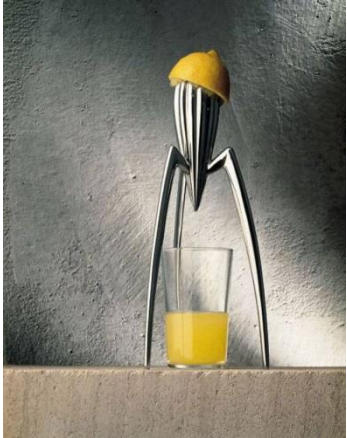

Juicy Salif lemon squeezer



Axor



Mama Shelter Istanbul



Baccarat Zenit Noir Chandelier



Kartell Louis ghost



Motor Yacht A

“ Every object, every shape, every style must have a meaning, and it is this meaning that influences us every day.”

Philippe Starck



THE PRODUCT (DESIGN) SHOULD NOT DETERMINE US.

We should have the **FREEDOM** to choose the products we like.



The products should be a reflection of **OUR** lives and not the way around.

DESIGNED
BY
S+ARCK,[®]
DEFINED
BY
YOU.

The new line of kitchen appliances **Gorenje by Starck** follows that philosophy in its unique design language, using highly reflective materials that actually reflect our personality, our home and our lifestyle.



Design

Minimalistic and clean design

Minimalistic handle and buttons

Grey high reflective glass with metal effect

Unique chrome painted glass ceramic on hobs

Reflection of the **orange** colour in the glass



LINE UP

Glass appliances

Multifunction ovens



BI MW



FS MW



Multifunction ovens



BI combi MW



Heating
Drawer



Pyrolitic oven

Vertical hood 60cm



Vertical hood 90cm



T wall hood 90cm



Hi-Light



Induction



Flex induction



Gas hob on glass ceramic



Decor panels for
Dishwasher



BI
177cm



FS
185cm

OVENS/DRAWERS



Model
BO747ST



Model
BOP747ST



Model
BO547ST



Model
BCM547ST

Model
WD14ST



Model
BO637ST



Model
BM251ST



Model
MO23ST



BIG SPACE

Volume matters



- Capacities range up to **75L** in 60cm multifunction ovens and up to **53L** in 45cm microwave ovens, which provide up to **15%** more internal space than our previous models, while their outside dimensions remain the same.

NEW HOMEMADE SHAPE

Traditional wood-burning style dishes in the modern environment of your home

- Neutral look in all ovens chamber at front
- Keep HomeMade “vault design” at back side.
- Enable hot air to move around freely and the food is heated evenly and from all sides.



MULTIFLOW 360°

Demand only the perfect results

- MultiFlow 360° guarantees the optimal circulation of heat within the oven.
- Due to smartly positioned ventilation openings on the back wall and the unique round shape, air is spread evenly throughout the oven.



GENTLE CLOSE

Smooth and silent

- Only a soft touch is needed to close the oven door smoothly, without any noise.
- Robust and long lasting - over 20,000 openings



ULTRA COOL DOOR*

No burning at all

- Triple glazed door with two reflective layer: temperature less than **35 °C**.



*on Multifunction oven

SILVER MATTE

Ultra resistant, ultra smooth coating

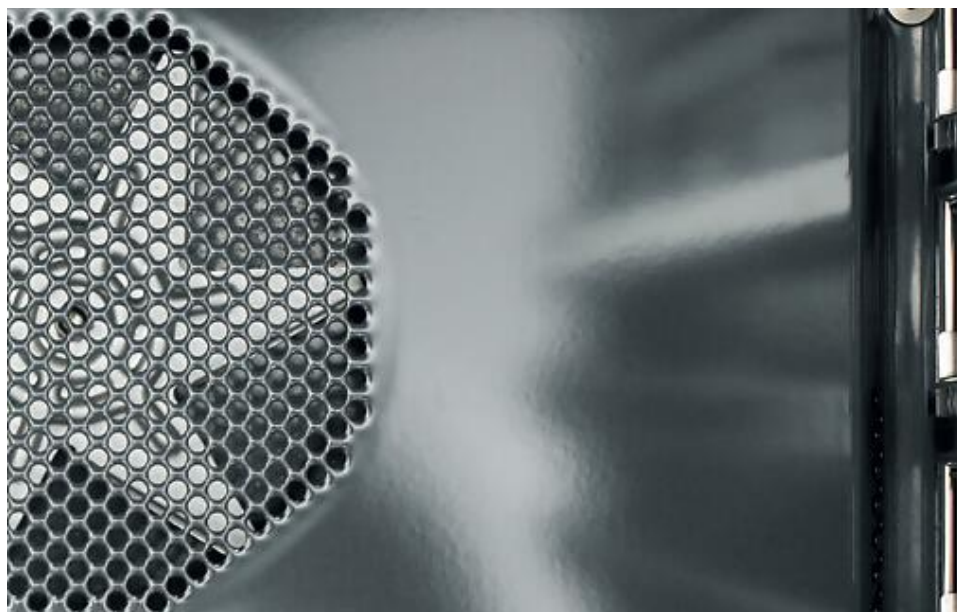

- 100% controlling process and with robot spraying of powder enamel
- Highly resistant material that can stand extreme heats and Pyrolytic cleaning at 500 degrees.
- The new non-stick enamel coating prevents fat from adhering to the surface of the oven or the tray, which in turn makes cleaning a piece of cake.
- The triple coating of the interior decrease scratches on the surface of tray and oven.
- Optimal and homogeneous thickness of vitreous enamel without any defects.

PYROLITIC CLEANING*

Premium self-cleaning function



- Pyrolytic cleaning is the most efficient and advanced way to clean the oven.
- The high cleaning temperature (up to 500°C) leaves the oven completely clean, without any spot of grease or any leftovers.
- At the end, only the residue is left to be wiped away.
- Duration options are 90min, 120min and 150min.

*on Pyrolitic oven

INVERTER TECHNOLOGY*

Gentle treatment for tastier food



- Because of Inverter technology the energy is **evenly distributed** instead of pulsating.
- As a result, the food retains its initial structure, including its vitamins, minerals and fibers.
- Energy efficiency

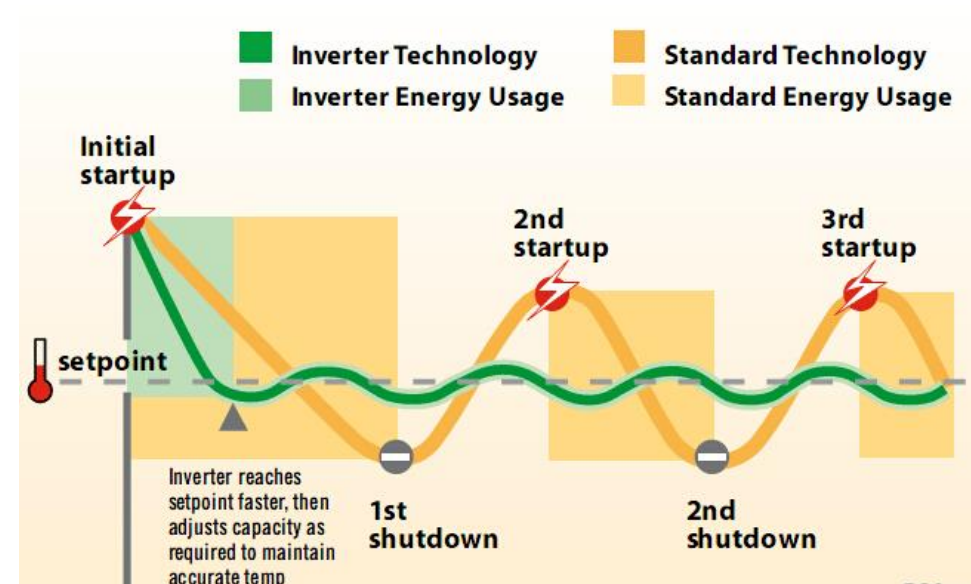

*on Microwave oven

STIRRER TECHNOLOGY*

Trays of all sizes are welcome



- The advanced microwave distribution system **heats the food uniformly** across the entire volume.
- The Stirrer technology permits a standard-size baking tray to be placed in a microwave oven.
- The oven's entire width is used, saying goodbye to conventional turntables and uneven heating.

*on Microwave oven

STAY WARM & WARM PLATE & YOGHURT

Multifunction drawer



- Keeps food at a constant temperature of **70°C** until the time is right to serve the meal.
- The food retains its original flavor and temperature until it is served.
- Prevent the loss of flavor and ensure that food tastes every bit as good as it should: from soups to pastas and steamed vegetables.
- Keep your crockery at precisely the right temperature – anywhere between **30 and 80°C**.
- Automatic temperature and time settings provide optimal conditions that create **homemade yoghurt** in around **4 hours**.

HOBS

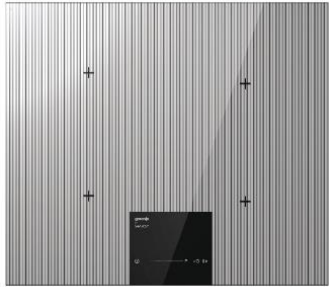

Model
IS634ST

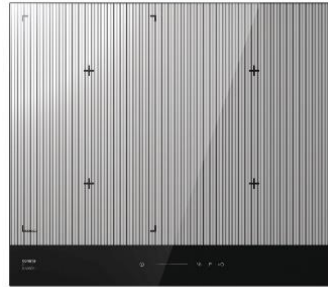

Model
IS655ST

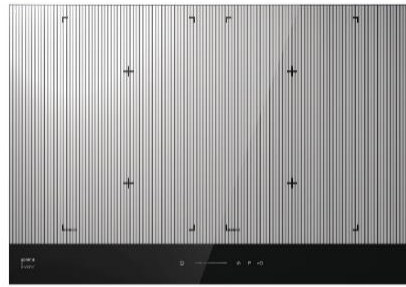

Model
IS756ST



Model
ECS693ST



Model
GCW641ST

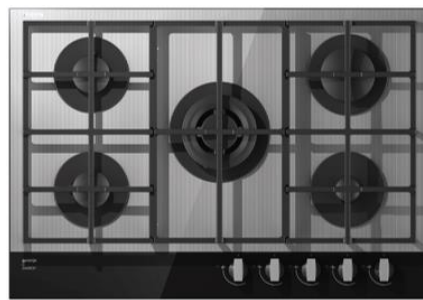

Model
GCW751ST



XPAND ZONE

When you expect a lot of guests

- The cooking zones on the left or right side of the hob can be combined into one extra-large cooking zone that can easily cook food like big fish.
- Space for larger cookware, or space for several smaller pots or pans.



POWER BOOST

When time is your most precious value

- PowerBoost provides extreme heat intensity to the pot and significantly cuts waiting time.
- It takes just **5.7 minutes** to boil **2L** of water, which is extremely time-efficient.



HIGH EFFICIENCY BURNER

Demand the highest efficiency

- Significantly improved gas burners provide up to 10% more efficient gas consumption.
- Better heat distribution over the whole surface of the pan base.
- The flame is directed to the base of the pan by the precision engineered flame ports.



WOK BURNER

Impress your guests with an eastern touch

- The wok burners reach a high heat very quickly, making Asian style cuisine and meals in big pots easy.
- No matter Yangchow fried rice or Kung Pao chicken, you can easily cook in your European style kitchen now.



POWER ZONE

Cook fast but efficient

- Starck hilight hob is also equipped with the boosting power **3kW** cooking element, allowing you to cook much faster while using less power.



HOODS



Model
WHI641ST



Model
WHI941ST



Model
WHT941ST



ADAPT TECH

So you can focus on cooking

- The sensor detects the level of impurities or steam, humidity and gases. The hood automatically adjusts the fan speed accordingly or even completely stops the fan after **10 minutes** when it is no longer needed.

P.A.S. SYSTEM

Listen to only what you want to hear

- The innovative **Parametric Air Suction** system redirects air extraction from the central part to the outer edges of the hood.
- This approach optimizes energy consumption, reduces noise and makes air extraction considerably efficient.
- Starck line Vertical hoods Noise level at max. speed: **59 dB**
T-shape hoods Noise level at max. speed: **62 dB**
Just a little above normal conversation.

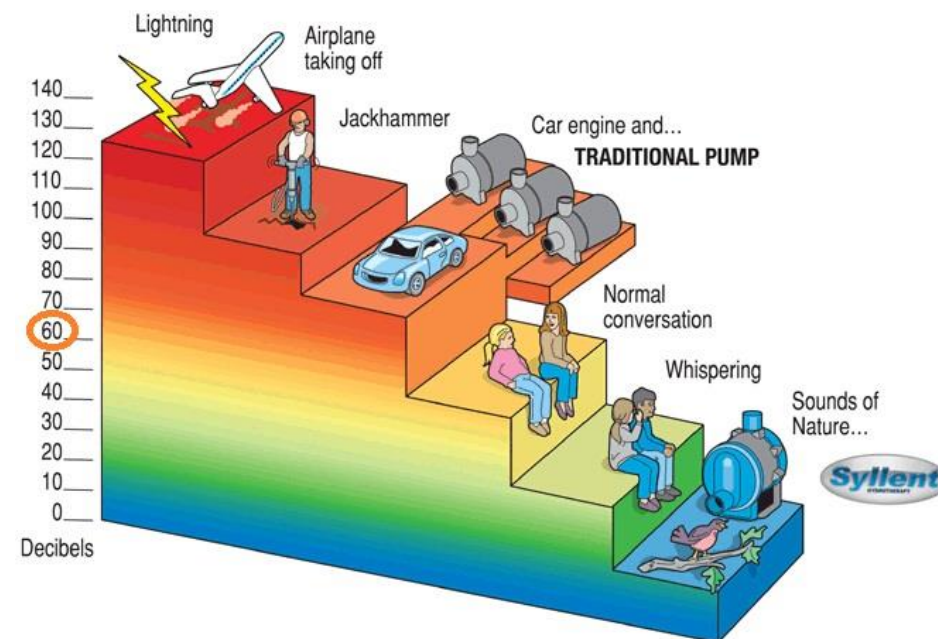

TIMER AND REFRESH

Keeps your kitchen always fresh

- Hoods can be automatically switched off in **30 minutes**.
- The refresh function is activated every hour and automatically starts refreshing the air for **10 minutes**.

SLIDER TOUCH

Everything is under your control

- A special innovative slider enables easy and instant changes between different power levels and lighting intensities.



COOLING



Model
NRK612ST



Models
NRK1512ST,
DPR-ST



ION AIR WITH MULTIFLOW 360°

Every shelf should be the best shelf

- Emulates the natural process of ionization to keep the food fresh longer: negative ions can prevent growth of bacteria and erase bad odors.
- The MultiFlow 360° ventilation system evenly distributes the cold air through **14 ventilation slots** to maintain constant temperature on every shelf.
- Ionizer also can be switched off.



ADAPT TECH

A refrigerator that reflects your habits

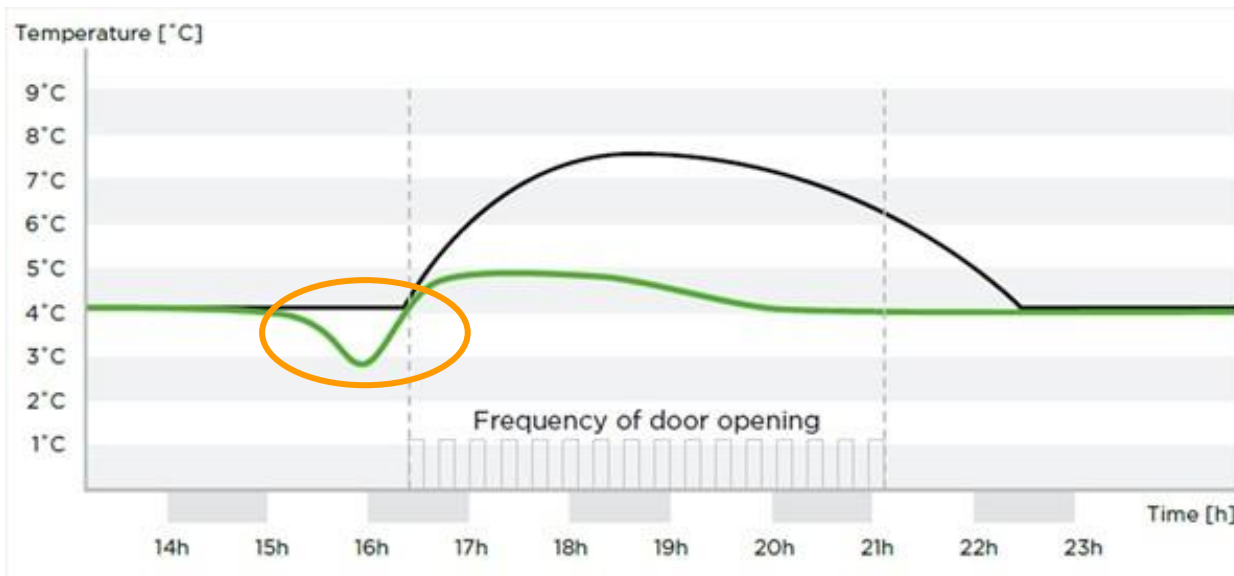

- LINE OF TEMPERATURE OSCILLATIONS IN A REGULAR REFRIGERATOR
- LINE OF TEMPERATURE OSCILLATIONS IN REFRIGERATOR WITH ADAPTTECH TECHNOLOGY

- When the door is opened, the temperature suddenly rises and the food is exposed to a thermal shock which in turn causes it to perish sooner.
- The refrigerator continuously monitors and analyzes the way you use it.
- Thus, it can predict when you will open the fridge door and just before you do, it **decreases** the temperature by **1 or 2 °C** to make sure **constant temperature** is maintained and that the food stays fresh and full of nutrients.

NO FROST PLUS

Freezes only what you want to freeze

- In the freezer compartment, it prevents the accumulation of ice and frost to keep the power consumption low.
- **Circulation** but direct blowing of cold air prevents the food from drying out and retains its vitamins and minerals in refrigerator compartment.



DÉCOR PANELS



Model
DFD70SST



Model
DFD70ST



Marketing communication

Product range images

Ambient photos, detailed photos, features and product photos

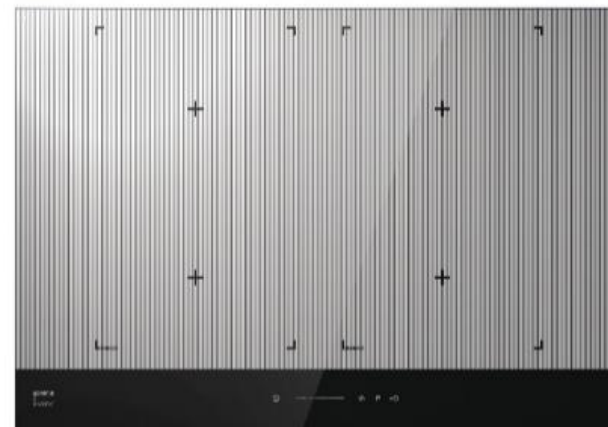

3D files

DWG, EPS and PDF file

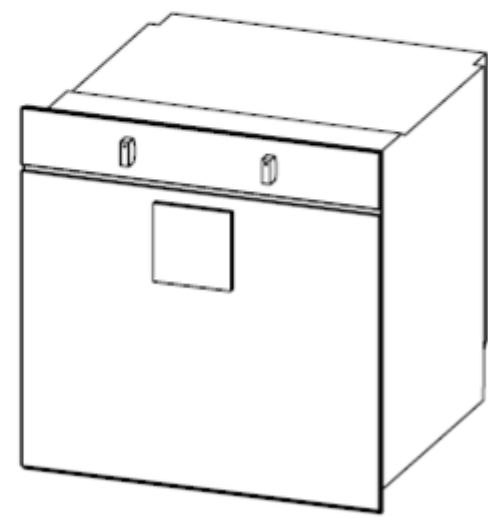
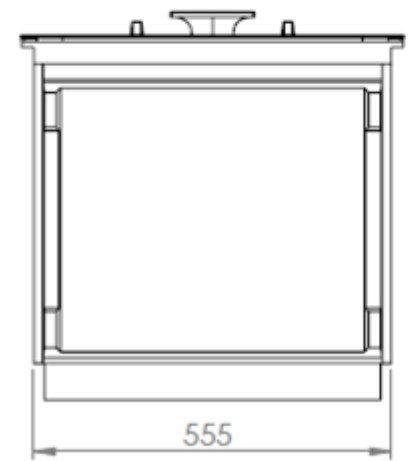
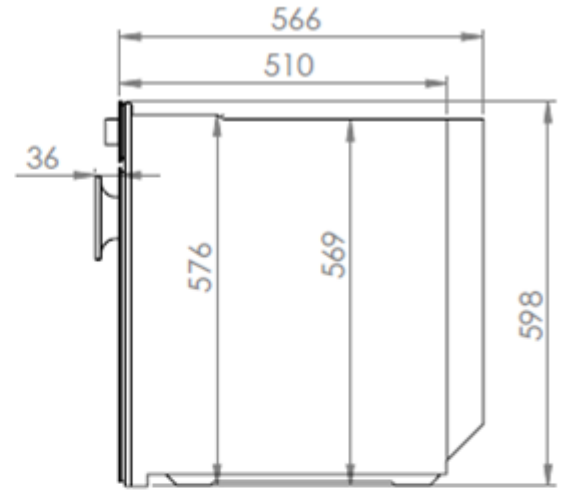
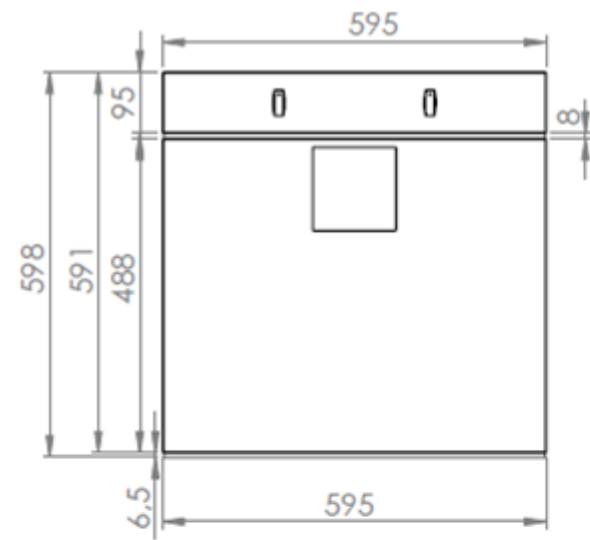

Sales brochure – English version

Content : about Starck, philosophy, product line and detailed specification

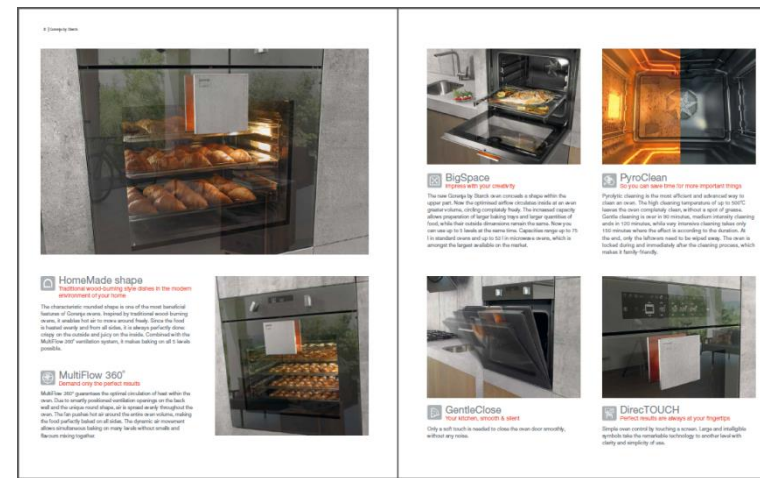
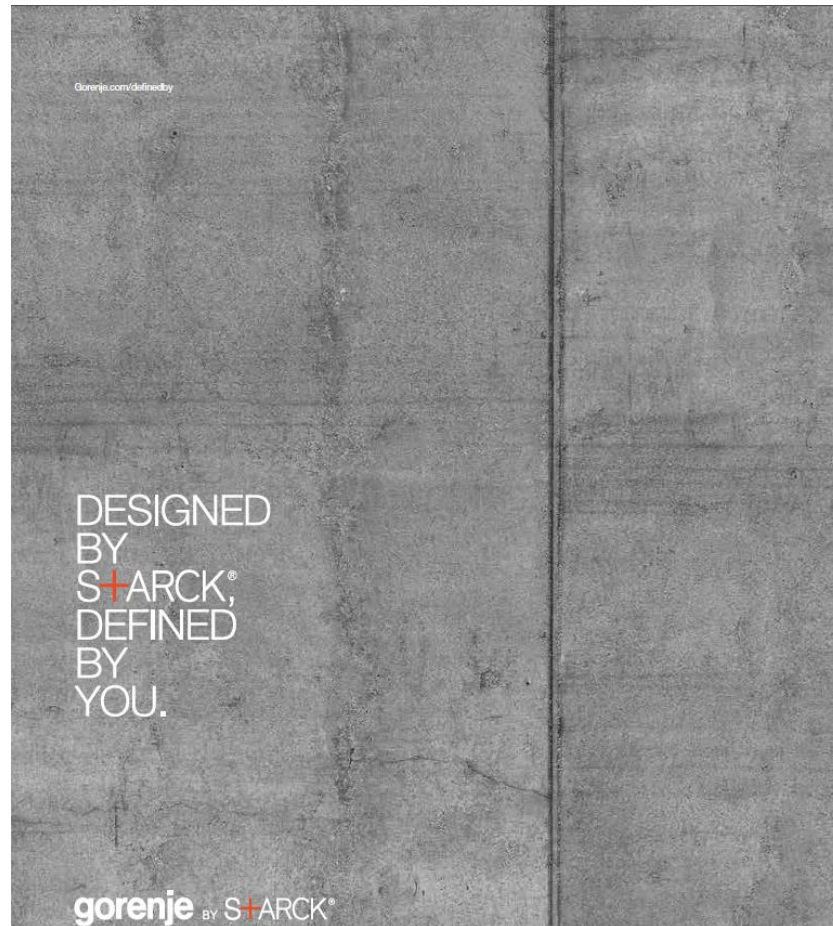

*Text available for translations

Printed Adds



gorenje BY **S+ARCK**®

DESIGNED BY **S+ARCK**®, DEFINED BY YOU.

THE NEW COLLECTION.

The new line of Gorenje kitchen appliances is designed by one of the most distinctive creators in the world – Philippe Starck. Minimalistic design with high end materials and reflective glass will make your kitchen a true reflection of who you are.

gorenje.com/gbs

- Possibility of translations into local language



gorenje BY **S+ARCK**®

DESIGNED BY **S+ARCK**®, DEFINED BY YOU.

THE NEW COLLECTION.

Get inspired with the new Gorenje by Starck collection. Choose from a whole range of 100 % matching design kitchen appliances and build your own unique kitchen. Its timeless design will reflect your personality, home and lifestyle as it blends perfectly into your environment.

gorenje.com/gbs

Internet communication material

- E - newsletter template
- Web banners
- Filmstrips

S+ARCK®

gorenje

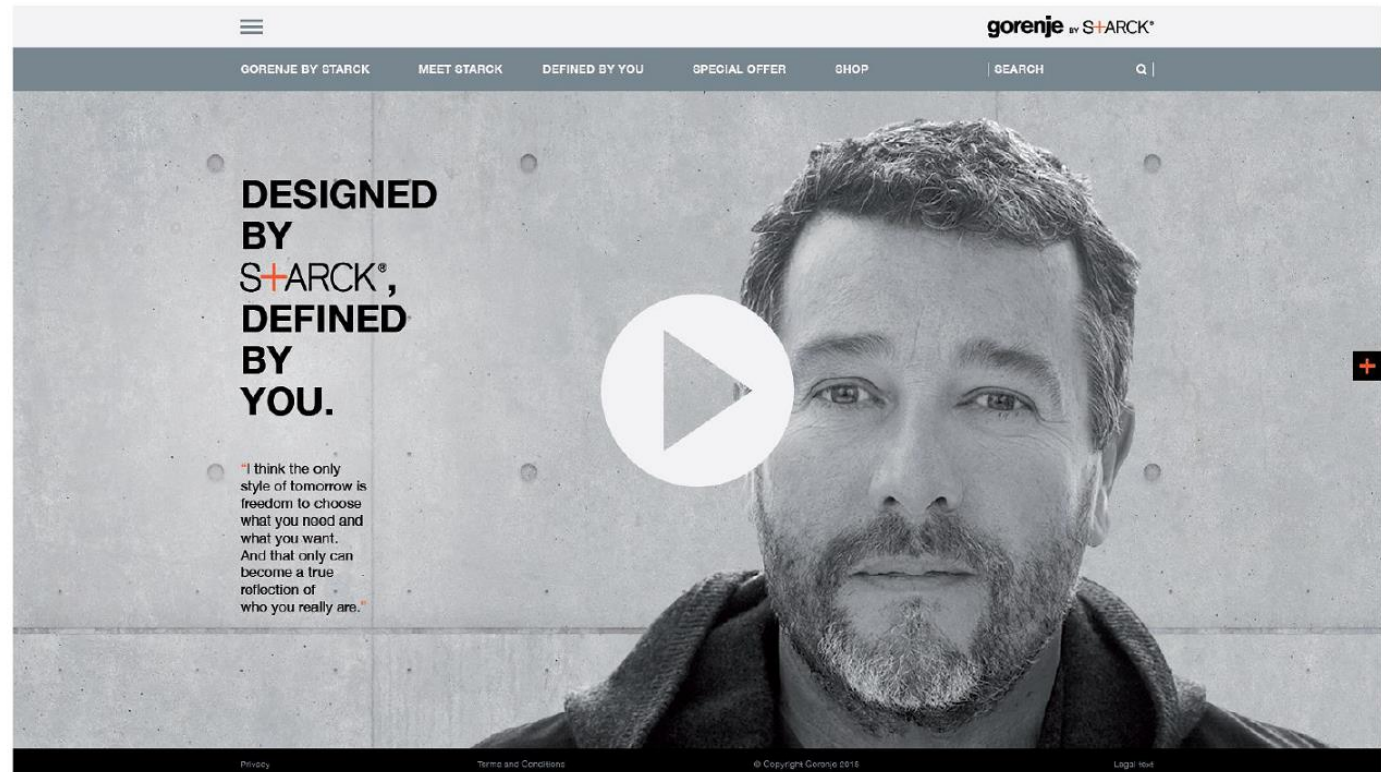

Video

For web, fairs, promotions, presentations, in - store



*Additional video: Interview with Philippine Starck

POS

Display options - showroom concept

- Showroom concept



- Fair concept



POS

Display option – shop in shop and retail solutions

Different combinations of appliances according to specific gama, needs or product limitations



Stickers

Version 1

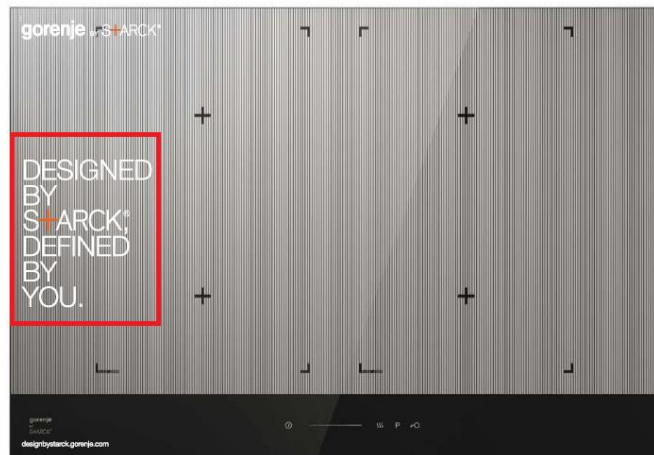

Version 2



Starck launching event guidelines

- Venue of the event can be a nice, high end place (it can also be related to Starck) or Gorenje showroom
- Highlighting the orange colour - an attribute of Starck designs
- Highlighting reflection – the main feature of Gorenje new line
- Recommended music for the event in the background is ZAZ music (favorite Starck artist)

Kindly note that all the events should be carefully discussed with Gorenje before initiation!

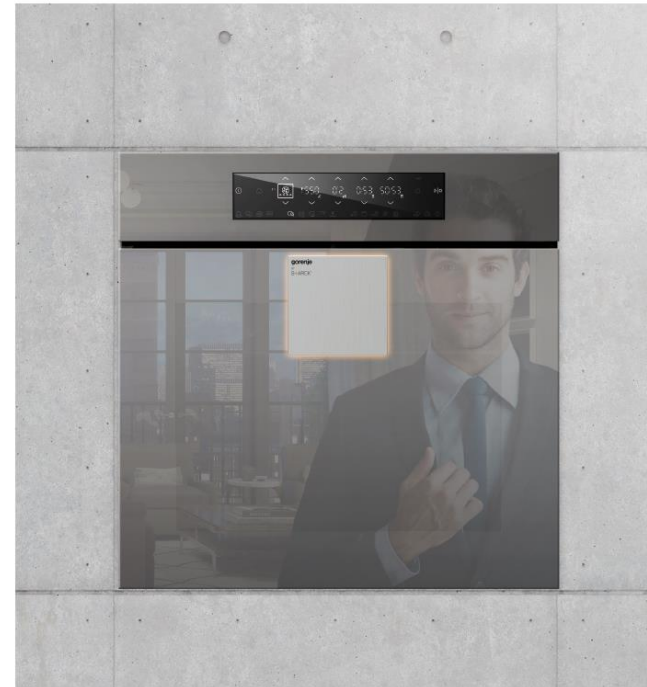

Give-Away to support launching event

Notepad

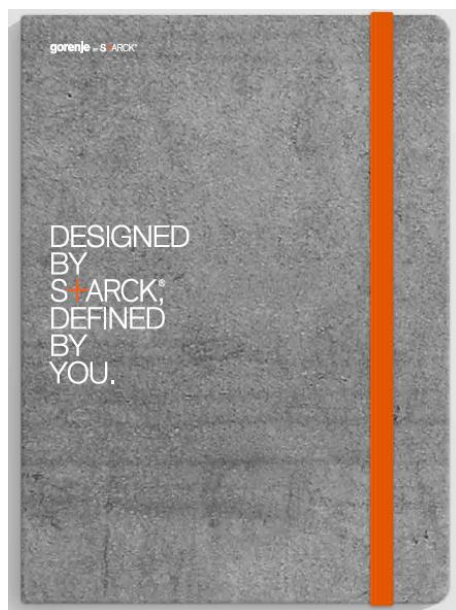

USB key



Gift bag



Thank you